

# *My* **BERNINA** Sergers Workbook 1



## **Basic Serger Use** For all current BERNINA sergers

Introduction..... 3

4-thread Balanced Stitch ..... 6

Adjusting Tension Settings..... 7

Micro Thread Control..... 8

Stitch Length..... 9

Cutting Width ..... 10

Differential Feed ..... 11

Securing Serged Seams..... 14

Presser Foot Tape Guide..... 15

3-Thread Balanced Stitch: Wide and Narrow ..... 16

Inside Corners ..... 17

Outside Corners ..... 18

3-Thread Rolled Hem ..... 19

3-Thread Flatlock..... 20

2-Thread Rolled Hem ..... 21

2-Thread Flatlock..... 22

Color-Coded Threading Charts ..... 23



The information in this workbook applies to the current line of BERNINA Sergers. *Note: Some exercises apply only to certain models equipped with the feature being highlighted.*

Congratulations on the purchase of your new BERNINA serger. The information in this workbook will help you learn the basics of using your new piece of sewing equipment. Even though it is very different from your sewing machine, once you learn to incorporate serging techniques into your sewing, you'll wonder how you ever got along without it.

Sometimes called the microwave of sewing, your serger will speed your sewing in several ways, letting you produce more in less time. The speed of the serger is faster than a sewing machine and because it performs several operations (trimming, seaming, and overcasting) at the same time, you sew faster, and in the process, produce neater and more professional-looking results.

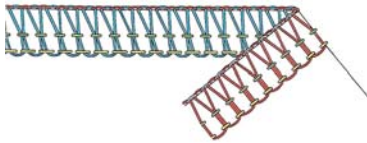

4-thread Balanced Stitch

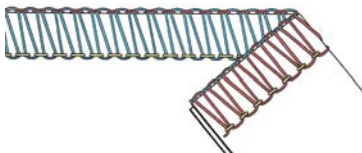

3-thread Balanced Stitch

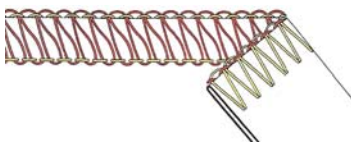

2-thread Balanced Stitch

Because the serger is a specialized piece of equipment, it only “sews” a limited number of techniques and even though the workings are more complex than a sewing machine, it doesn't take long to learn the basics. The stitching exercises in this workbook use four, three, and two thread stitch formations.

Once you have completed the exercises designated for your BERNINA overlock machine, attach the sewn samples to the indicated pages and insert the pages into plastic page protectors and store them in a 3-ring binder. They can then be used as a reference tool in the future as you use your serger and explore the creative possibilities it affords you.

BERNINA of America, Inc. strives to provide its customers with quality sewing and overlock machines, and also with informative publications and classes. Along with providing My BERNINA Classes, your local BERNINA dealer stocks BERNINA books and magazines, such as *Feet-ures*, *Serger Technique Reference Guide*, *Through the Needle* Online magazine. You will also find a wealth of serger information on the BERNINA of America website at [www.berninausa.com](http://www.berninausa.com).

Each BERNINA serger is identified by a model number followed by a series of letters. These letters indicate special features for that particular model.

Current BERNINA models:

1300MDC

1150MDA

800DL

700D

### Overlock Model Name

Example: 1300 MDC

↓                      ↓  
Model Number    Special Features

**A** = Automatic Needle Threader

**C** = Coverstitch / Chainstitch

**D** = Differential

**L** = Looper Threading Device

**M** = Micro Thread Control

## Serger Needles

BERNINA sergers use the same type of needle as most sewing machines: 130/705H. *Note: An exception to this is the JLx2 needles that can help perfect the cover stitch on models 1300 MDC and 009DCC.*

Use size 80/12 or 90/14 needle in your serger; larger needles can interfere with looper movement and cause damage; smaller needles may not form the stitches correctly.

Always make sure needles are fully inserted as high as possible, with the flat side to the back.

When using both the right needle and the left needle, the needles will not be even with they are fully inserted. The left needle will be slightly higher than the right one.

## Serger Thread

Serger threads are usually polyester and are finer (lighter weight) than many sewing machine threads to avoid thread build-up and excessive bulk in seams. It is important that serger thread is smooth without variations in diameter as it needs to feed smoothly through many thread guides for good stitch formation. You also want a good-quality thread – such as Mettler Metrocor – that is not “fuzzy” and does not leave excessive lint in the lower part of your overlock machine. Serger threads are sold on cones for economy and convenience; regular spools of thread may be used but will not last very long when forming serger stitches. Along with serger thread, there are applications that call for specialty and decorative threads. Listed below are some of these threads commonly used in the serger:

Texturized Nylon Thread – such as YLI Woolly Nylon and Mettler Metroflock. A very elastic thread with excellent coverage; perfect for rolled edges and knit seams. Available in solid and variegated colors, and metallics.

Polyester Topstitching Thread – such as YLI Jeans Stitch & Mettler Cordonnet – this heavy thread is used for decorative stitching (flatlocked seams and overcast edges). Also nice for cover and chain stitching. Available in solid and variegated colors.

Rayon Decorative Threads – such as YLI Pearl Crown Rayon & YLI Designer 6 – shiny threads for decorative applications. Pearl Crown Rayon is twisted, while Designer 6 is untwisted. Available in solid and variegated colors.

Metallic Decorative Threads – such as YLI Candlelight – adds a bit of glitz to seams and edgings.

Decorative Sewing Threads – sewing machine threads can also be used in the serger, and are particularly effective when several are used together as one thread.

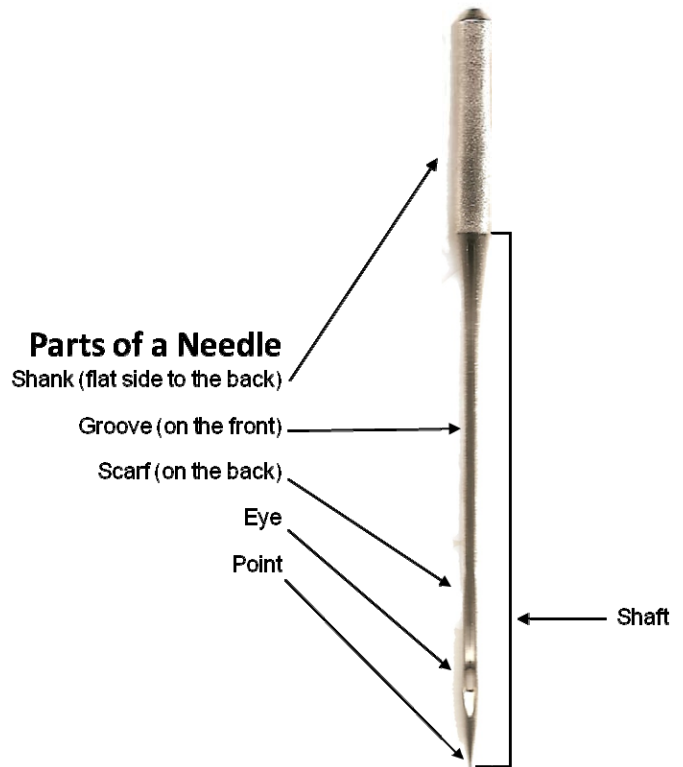

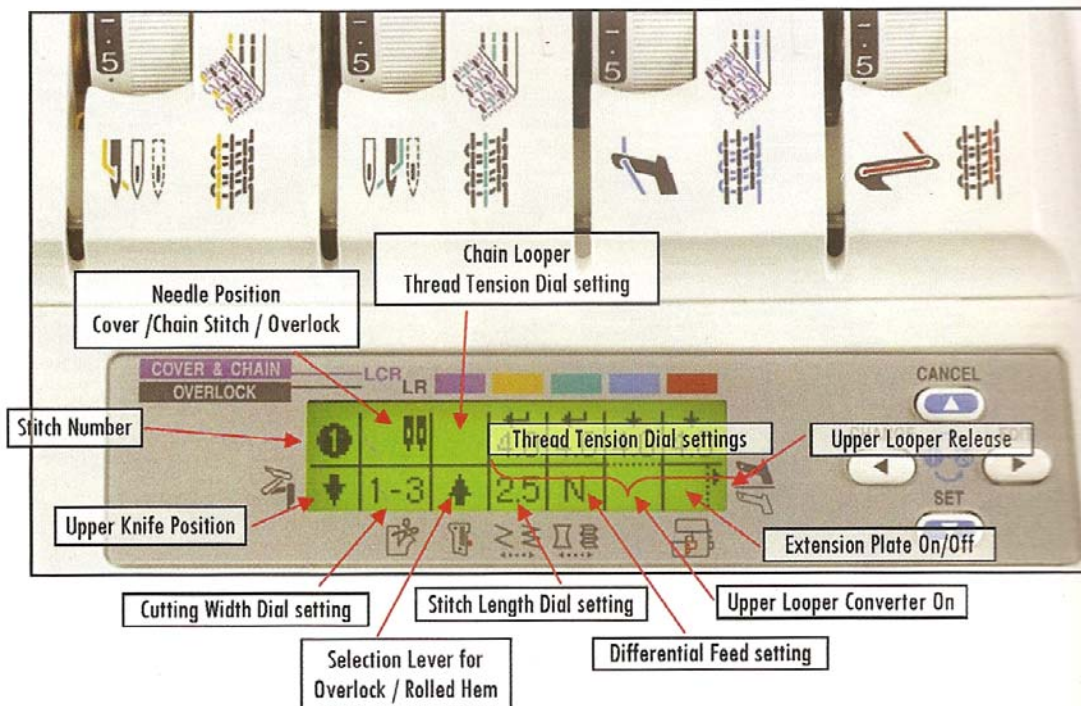

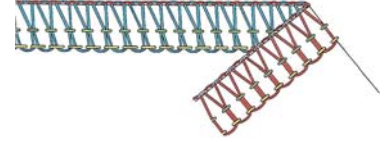

- Fabric:** Firm fabric, 6" x 6"
- Needle:** 80/12 Universal
- Thread:** 4 cones of serger thread (blue, red, green, yellow)
- Presser Foot:** Standard
- Stitch:** 4-thread overlock

Thread the serger for a 4 thread overlock stitch using thread colors to match the color-coded threading path on the serger. Adjust all thread tension settings as indicated below.

Fold the fabric in half to 3" x 6".

To begin stitching, lift the front of the presser foot with your right thumb and slide the fabric under the presser foot. Release the tip of the presser foot and begin serging, trimming the fold away.

Serge to the end of the fabric. Continue stitching off the fabric until you have a 3"- 4" thread chain. Cut thread chain.

Examine the serger stitch formation:

- Blue: Loops should extend to the edge of the fabric, interlocking with the red loops of the lower looper.
- Red: Loops should extend to the edge of the fabric, interlocking with the blue loops of the upper looper.
- Yellow: Needle stitches should appear along the inside edge of the stitch as straight stitches or tiny "dots" of thread.
- Green: Needle stitches should appear as a line of straight stitching running through the middle of the serger stitching

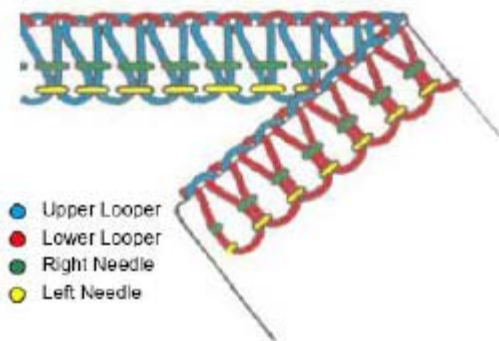
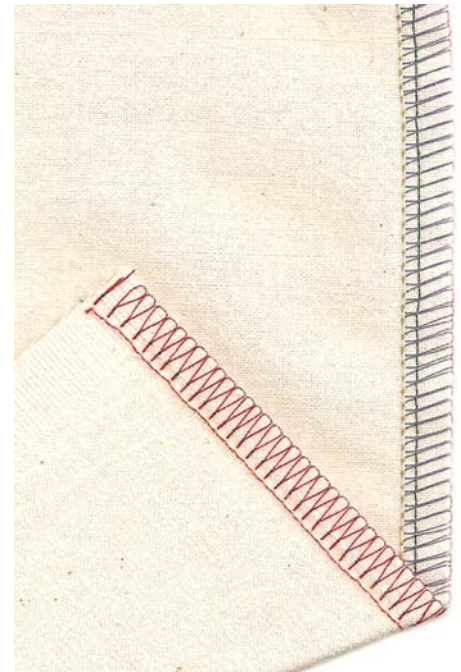

**Suggested Settings**

Upper Looper.....	3-5
Lower Looper.....	3-5
Left Needle .....	3-5
Right Needle.....	3-5
Stitch Length.....	2.5
Cutting Width .....	2-3
Differential Feed .....	N

See the following page for tension adjustment information. Make any necessary tension adjustments and serge another row of stitching.

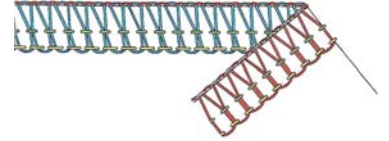

Examine Your 4-thread sample. The illustrations below show examples of unbalanced stitches and how to correct the settings to balance the stitch. When making corrections in the tension settings, increase or decrease the settings as needed, moving the dial ½ to 1 number at a time. Stitch a seam using the new settings and then evaluate the new stitch. Continue in this manner until the stitch is balanced.

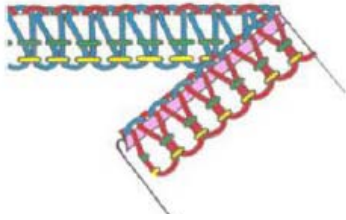

### Upper and Lower Loopers - Tight Tension

*Unbalanced:* The looper threads “bite” into the edge of the fabric and/or the seam allowance is folded or “scrunched” in the stitch.

*Correction:* Decrease (lower number) one or both looper tensions until the seam allowance is flat and loopers meet at the edge. *Note: This problem might also result from an incorrect cutting width setting; see page 10 for more information.*

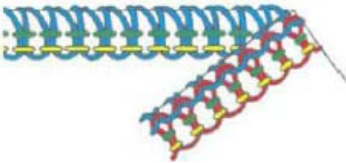

### Upper Looper - Loose Tension

*Unbalanced:* The looper threads are not at the edge of the fabric. Upper looper thread is visible on the back of the fabric and the looper threads are very loose.

*Correction:* Make sure the thread is seated in the tension guides. If it is, tighten the upper looper thread (higher number).

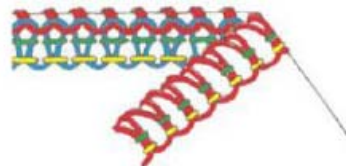

### Lower Looper - Loose Tension

*Unbalanced:* The looper thread does not lock on the edge of the fabric. Lower looper thread is visible on the face of the fabric. The looper threads are very loose.

*Correction:* Make sure the thread is seated in the tension guides. If it is, tighten the lower looper thread (higher number).

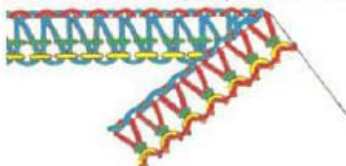

### Left Needle - Loose Tension

*Unbalanced:* The yellow needle forms loops on the underside of the fabric. The seam is not secure and the yellow thread may show in the seam line.

*Correction:* Make sure the yellow thread is seated in the tension guide. If it is, tighten the left needle tension (higher number).

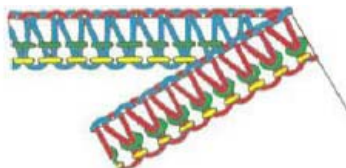

### Right Needle - Loose Tension

*Unbalanced:* The green needle thread forms loops on the underside of the fabric.

*Correction:* Make sure the green thread is seated in the tension guide. If it is, tighten the right needle tension (higher number).

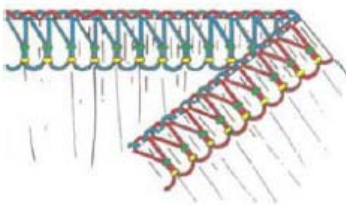

### Right and Left Needles - Tight Tension

*Unbalanced:* The green and yellow needle threads are pulled snugly, causing puckers in the fabric at the seam line.

*Correction:* Make sure the threads are seated in the tension guides or have not double-wrapped around a threading guide. If they have, unwrap or loosen appropriate needle tension (lower number).

**Fabric:** Firm fabric, 6" x 6"  
**Needle:** 80/12 Universal  
**Thread:** 4 cones of serger thread (blue, red, green, yellow)  
**Presser Foot:** Standard  
**Stitch:** 4-thread overlock

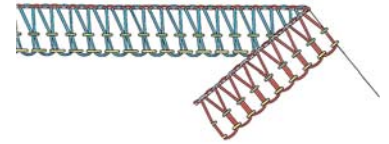

Divide the fabric into 4 equal sections along one side, finger-press the folds to form creases.

Thread the serger for a 4 thread overlock stitch using thread colors to match the color-coded threading path on the serger. Adjust all thread tension settings as indicated below.

Set the *mtc* lever to the maximum setting, serge on the first fold.

Move the *mtc* lever to the normal setting, serge on the second fold.

Move the *mtc* lever to the minimum setting, serge on the third fold.

Mark the sample:  
*mtc* - maximum  
*mtc* - normal  
*mtc* - minimum

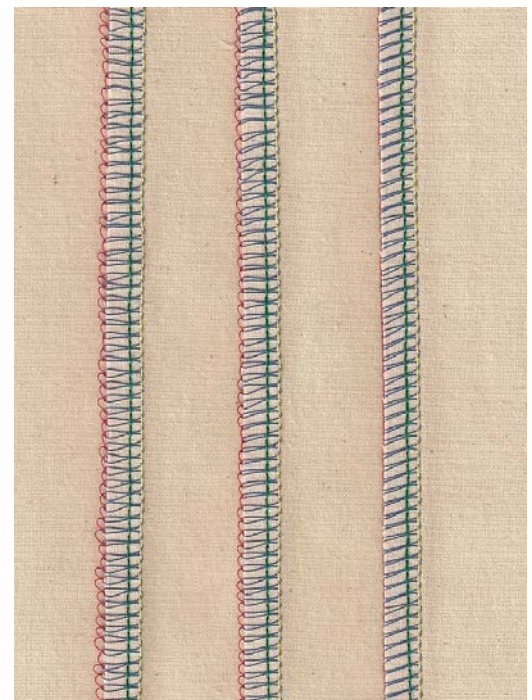

maximum    normal    minimum

*Note: The mtc function is a fast and easy way to make a stitch formation look perfect without having to adjust multiple thread tension. Different fabrics and threads will affect the formation of the stitch so the mtc setting may vary from fabric to fabric.*

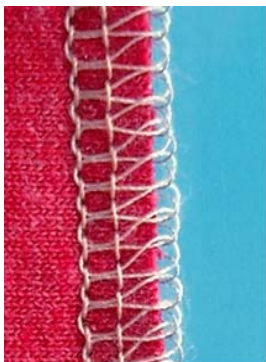

before mtc adjustment

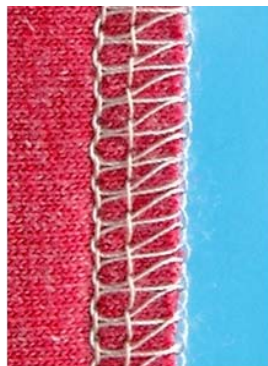

after mtc adjustment

### Suggested Settings

Upper Loper .....	3-5
Lower Loper .....	3-5
Left Needle .....	3-5
Right Needle .....	3-5
Stitch Length .....	2.5
Cutting Width .....	2-3
Differential Feed .....	N



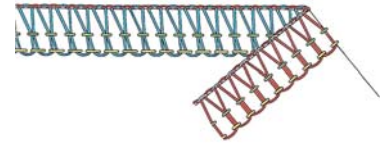

**Fabric:** Firm fabric, 6" x 6"  
**Needle:** 80/12 Universal  
**Thread:** 4 cones of serger thread (blue, red, green, yellow)  
**Presser Foot:** Standard  
**Stitch:** 4-thread overlock

Fold fabric in half to 3" x 6".

Using a fabric marker, divide the fabric into four equal sections along the folded edge.

Thread the serger for a 4 thread overlock stitch using thread colors to match the color-coded threading path on the serger. Adjust all thread tension settings as indicated below.

Adjust the stitch length to 4mm. Serge to the first mark along the folded edge, trimming the fold slightly.

Adjust the stitch length to 3mm and serge to the second mark.

Adjust the stitch length to 2mm and serge to the third mark.

Adjust the stitch length to 1mm and serge to the end.

Mark the stitch length settings on the fabric sample.

Return stitch length to its normal setting, 2.5mm.

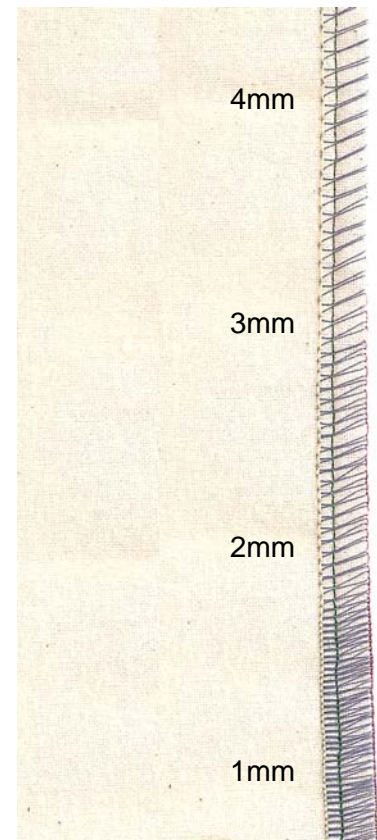

Stitch length adjustments may be needed to accommodate thicker or thinner threads or different weights of fabric. General guidelines for stitch length settings:

- 1-1.5mm: rolled hems and decorative edges
- 2-2.5mm: seaming and general serging
- 3-4mm: certain techniques such as gathering and applying elastic

### Suggested Settings

Upper Loper.....	3-5
Lower Loper.....	3-5
Left Needle .....	3-5
Right Needle.....	3-5
Stitch Length.....	varies
Cutting Width .....	2-3
Differential Feed .....	N

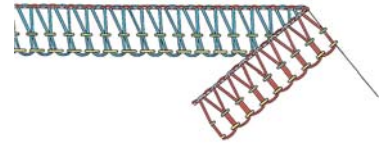

**Fabric:** Firm fabric, 6" x 6"  
**Needle:** 80/12 Universal  
**Thread:** 4 cones of serger thread (blue, red, green, yellow)  
**Presser Foot:** Standard  
**Stitch:** 4-thread overlock

Fold the fabric in half to 3" x 6".

Divide and mark the fabric into three equal sections along the folded edge.

Thread the serger for a 4 thread overlock stitch using thread colors to match the color-coded threading path on the serger. Adjust all thread tension settings as indicated below.

Rotate the upper knife up. Adjust cutting width to the widest setting. Rotate the upper knife down into cutting position.

Serge to the first mark on the fabric, stopping when the knife edge is on the mark.

Adjust cutting width to a mid-range setting and serge to the second mark.

Adjust the cutting width to the lowest setting and serge to the end of the fabric.

Mark the cutting width settings on the sample.

Rotate the upper knife up. Return the cutting width to its normal setting. Rotate the upper knife down into cutting position.

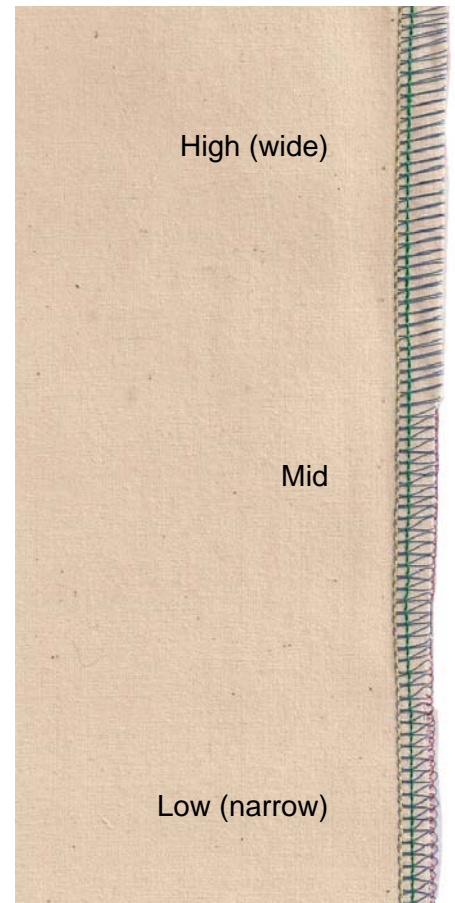

### Suggested Settings

Upper Looter.....	3-5
Lower Looter.....	3-5
Left Needle .....	3-5
Right Needle.....	3-5
Stitch Length.....	2.5
Cutting Width .....	varies
Differential Feed .....	N

# My **BERNINA** Differential Feed: Stretchy Fabrics

## Serger Workbook

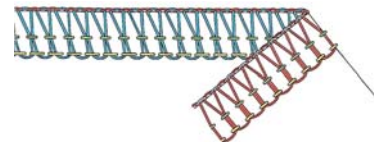

**Fabric:** Knit ribbing, three pieces, 3" x 6" each  
**Needle:** 80/12 Universal (ballpoint may be used if needed)  
**Thread:** 4 cones of serger thread (blue, red, green, yellow)  
**Presser Foot:** Standard  
**Stitch:** 4-thread overlock

Thread the serger for a 4 thread overlock stitch using thread colors to match the color-coded threading path on the serger. Adjust all thread tension settings as indicated below.

With differential set at N, serge two of the ribbing pieces together along one 6" edge. If the fabric is stretchy enough you will have a wavy or stretched seam.

Adjust the differential to 2.0. Serge the remaining ribbing to the other side of the first piece, trimming slightly. With differential at a higher setting, the wavy edge should be eliminated.

Mark the differential settings on the fabric sample.

Return the differential feed setting to N (normal).



N (normal)      2mm

### Suggested Settings

Upper Loooper.....	3-5
Lower Loooper.....	3-5
Left Needle .....	3-5
Right Needle.....	3-5
Stitch Length.....	2.5
Cutting Width .....	2-3
Differential Feed .....	N

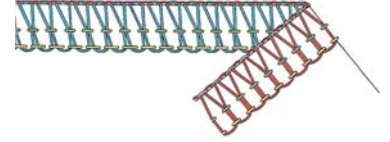

**Fabric:** Lightweight, soft, 4" x 6"  
**Needle:** 80/12 Universal  
**Thread:** 4 cones of serger thread (blue, red, green, yellow)  
**Presser Foot:** Standard  
**Stitch:** 4-thread overlock

Thread the serger for a 4 thread overlock stitch using thread colors to match the color-coded threading path on the serger. Adjust all thread tension settings as indicated below.

With differential set at N, serge on one 6" edge. If fabric is light-weight enough you will have a puckered edge.

Adjust the differential to 0.7. Serge along the other 6" edge, trimming slightly. With a low differential setting, the puckered edge should be eliminated.

Mark the differential settings on the fabric sample.

Return the differential feed setting to N (normal).



0.7mm

N (normal)

### Suggested Settings

Upper Loper.....	3-5
Lower Loper.....	3-5
Left Needle .....	3-5
Right Needle.....	3-5
Stitch Length.....	2.5
Cutting Width .....	2-3
Differential Feed .....	varies

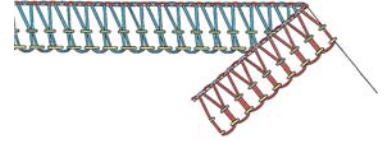

**Fabric:** Lightweight fabric, 6" x 12"  
**Needle:** 80/12 Universal  
**Thread:** 4 cones of serger thread (blue, red, green, yellow)  
**Presser Foot:** Standard  
**Stitch:** 4-thread overlock

Using a fabric marker divide the fabric into 3 equal sections along one 12" side.

Thread the serger for a 4 thread overlock stitch using thread colors to match the color-coded threading path on the serger. Adjust all thread tension settings as indicated below.

Turn the differential feed dial to 2. Serge to the first mark.

Adjust stitch length to 4mm and serge to the second mark.

Move the thread tension levers up to 8 to increase both needle thread tensions. Serge to the end of the fabric.

Return the differential feed to "N" (normal) and the stitch length to 2.5 (normal).

Move the thread tension levers to return tensions to normal (3-5).



## Suggested Settings

Upper Loper.....	3-5
Lower Loper.....	3-5
Left Needle .....	3-5
Right Needle.....	3-5
Stitch Length.....	varies
Cutting Width .....	2-3
Differential Feed .....	varies

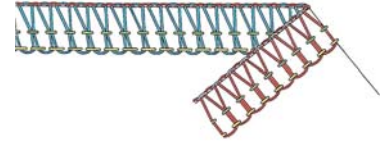

**Fabric:** Firm fabric, 6" x 6"  
**Needle:** 80/12 Universal  
**Thread:** 4 cones of serger thread (blue, red, green, yellow)  
**Presser Foot:** Standard  
**Stitch:** 4-thread overlock

Thread the serger for a 4 thread overlock stitch using thread colors to match the color-coded threading path on the serger. Adjust all thread tension settings as indicated below.

Stitch a 2"-3" thread chain without fabric.

Fold fabric in half to 3" x "6" and place under the presser foot.

Take 2-3 stitches on the fabric. Lower the needles into the fabric. Raise the presser foot and with your left hand gently pull the thread chain around the needles to the knife.

Lower the presser foot and continue serging (cutting off the excess thread chain) until you are one stitch off the end of the fabric.

Locate the Stitch Selection lever on the right side of the cloth plate; pull it toward you, releasing the thread chain from the stitch tongue.

Raise the presser foot and carefully flip the fabric over so that The lower looper side of the previously serged seam will be overstitched.

Place the fabric under the presser foot so that the first stitch will enter the fabric when you begin stitching.

Slide the Stitch Selection lever toward the body of the serger.

Serge for about 1", over stitching the previous stitching. Guide the fabric so as not to cut the previous stitching. *Optional: Rotate upper knife up.*

Raise the toe of the presser foot and rotate the fabric 90° clockwise.

Serge off the edge of the fabric.

If the upper knife is up, rotate it down into the cutting position.

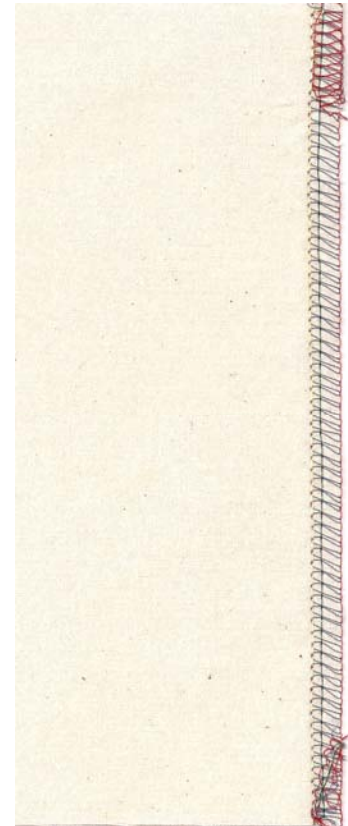

## Suggested Settings

Upper Looper.....	3-5
Lower Looper.....	3-5
Left Needle .....	3-5
Right Needle.....	3-5
Stitch Length.....	2.5
Cutting Width .....	2-3
Differential Feed .....	N

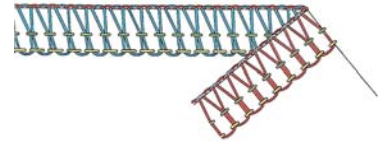

- Fabric:** Two pieces cotton interlock fabric, 3" x 6" each and Narrow twill tape, 8"
- Needle:** 80/12 Universal
- Thread:** 4 cones of serger thread (blue, red, green, yellow)
- Presser Foot:** Standard
- Stitch:** 4-thread overlock

Thread the serger for a 4 thread overlock stitch using thread colors to match the color-coded threading path on the serger. Adjust all thread tension settings as indicated below.

Locate the tape guide on the presser foot.

Using the small screwdriver from the accessory pouch, loosen the fixing screw and slide the tape guide all the way to the left. Snug the screw.

Slip the twill tape or ribbon into the slot on the presser foot and position it under the foot, pulling it to the back.

Lower the presser foot and lower the needles into the tape or ribbon.

Loosen the fixing screw and adjust the tape guide to the width of the tape or ribbon. Retighten the screw.

Place the fabric pieces right sides together. Slip the fabric under the foot and seam along the 6" side, catching the tape or ribbon in the serged edge.

Remove the fabric from under the presser foot and examine the seam. It will not stretch; the tape or ribbon has stabilized the seam.

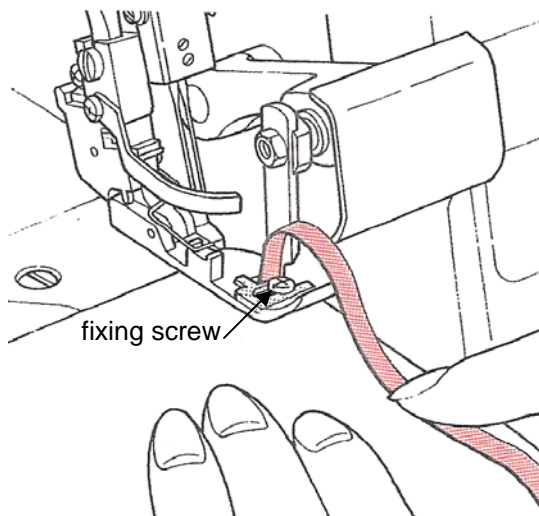

### Suggested Settings

Upper Looter.....	3-5
Lower Looter.....	3-5
Left Needle .....	3-5
Right Needle.....	3-5
Stitch Length.....	2.5
Cutting Width .....	2-3
Differential Feed .....	N

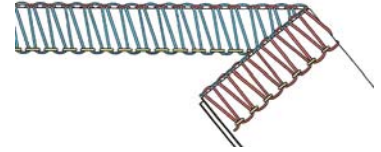

**Fabric:** Firm fabric, 8" x 6"  
**Needle:** 80/12 Universal  
**Thread:** 3 cones of serger thread (red, blue, green for narrow and red, blue, yellow for wide)  
**Presser Foot:** Standard  
**Stitch:** 3-thread overlock

## Wide Balanced Stitch

Using the small screwdriver and brush/needle insertion tool, remove the right needle. Snug the needle set screw after removing the needle.

Thread the serger for a *wide* 3-thread overlock stitch using the left needle and thread colors to match the color-coded threading path on the serger. Adjust all thread tension settings for a balanced stitch as indicated below.

Fold fabric in half to be 4"x 6". Serge along the folded edge of the fabric, trimming slightly to remove the fold.

## Narrow Balanced Stitch

Using the small screwdriver and brush/needle insertion tool, loosen the right needle screw and insert the right needle.

*Hint: Place the point of the needle directly above the right needle space of the presser foot, then lift the needle up to place the shank in the correct hole.* Tighten the right needle screw.

Remove the left needle. Snug the needle set screw after removing the left needle.

Thread the serger for a 3-thread *narrow* stitch using the right needle and thread colors to match the color-coded threading path on the serger. Adjust all thread tension settings for a balanced stitch as indicated below.

Serge along the raw edges opposite the wide balanced stitch.



## Suggested Settings

Upper Loper.....	3-5
Lower Loper.....	3-5
Left Needle (for wide stitch) .....	3-5
Right Needle (for narrow stitch)·	3-5
Stitch Length.....	2.5
Cutting Width .....	2-3
Differential Feed .....	N



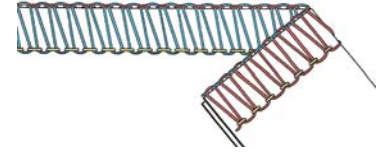

**Fabric:** Firm fabric, 6" x 6"  
**Needle:** 80/12 Universal  
**Thread:** 3 cones of serger thread (blue, red, green)  
**Presser Foot:** Standard  
**Stitch:** 3-thread overlock

Using the small screwdriver and brush/needle insertion tool, remove the left needle. Snug the needle set screw after removing the needle.

Thread the serger for a *narrow* 3-thread overlock stitch using thread colors to match the color-coded threading path on the serger. Adjust all thread tension settings for a balanced stitch as indicated below.

### Inside Corner

*This technique works well for continuous plackets on sleeves and back neck openings.*

- Cut an inside corner into the fabric.
- Snip into the corner about ¼" (the width of the stitching).
- Serge until the knife reaches the end of the cut.
- Use the handwheel to lower the needle into the fabric.
- Lift the presser foot and straighten the corner towards you.
- Lower the presser foot; continue serging.

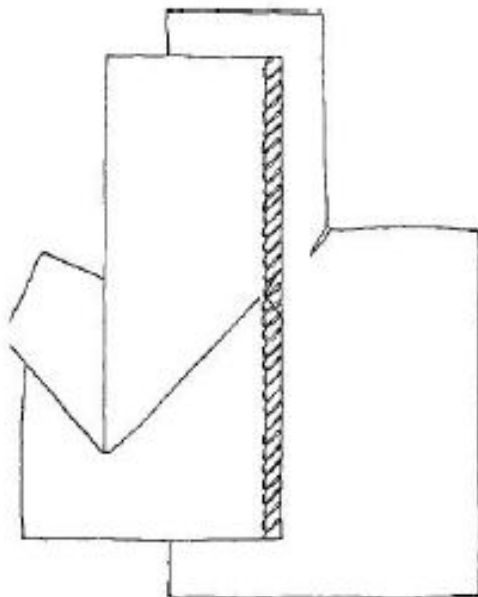
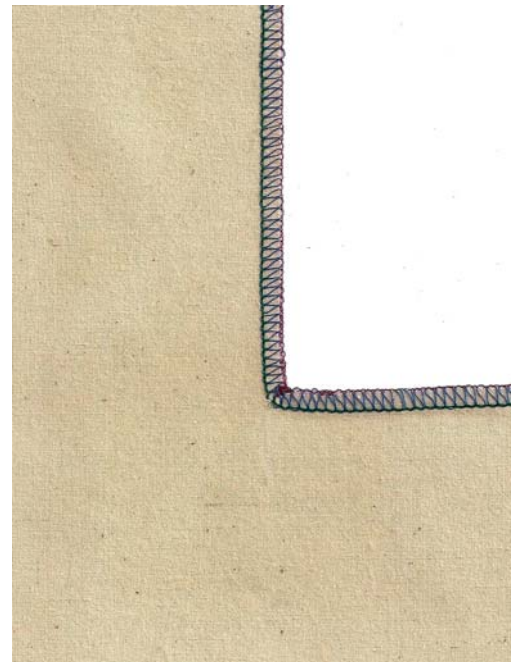

### Suggested Settings

Upper Loper.....	3-5
Lower Loper.....	3-5
Left Needle .....	N/A
Right Needle .....	3-5
Stitch Length.....	2.5
Cutting Width.....	2-3
Differential Feed.....	N

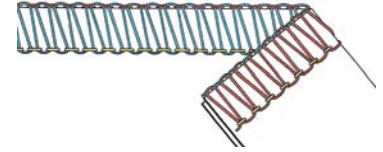

**Fabric:** Firm fabric, 6" x 6"  
**Needle:** 80/12 Universal  
**Thread:** 3 cones of serger thread (blue, red, green)  
**Presser Foot:** Standard  
**Stitch:** 3-thread overlock

Using the small screwdriver and brush/needle insertion tool, remove the left needle. Snug the needle set screw after removing the needle.

Thread the serger for a *narrow* 3-thread overlock stitch using thread colors to match the color-coded threading path on the serger. Adjust all thread tension settings for a balanced stitch as indicated below.

### Outside Corner

#### OPTION I

- Serge one edge of the fabric, stitching off the end of the fabric. Trim the thread tail.
- Continue serging around the square, crossing over previous stitching.
- Use a seam sealant on the untrimmed thread tails (or use a tapestry needle to weave the thread tail back through the stitching). When the seam sealant is dry, trim the thread tails.

#### OPTION II

- Before serging, trim away the seam allowance ( $\frac{1}{4}$ " ) for about 2" on each corner of the square.
- Beginning at one trimmed corner, serge (trimming very slightly as you sew) to the end of the fabric. Take one stitch off the end of the fabric.
- Locate the Stitch Selection lever on the stitch plate and pull it toward you. This will free the thread from the stitch finger.
- Lift the presser foot and carefully pivot the fabric 90° clockwise.
- Return the Stitch Selection lever to normal (away from you).
- Place the needle one stitch into the fabric and lower the presser foot.
- Continue serging until you are one stitch off the next

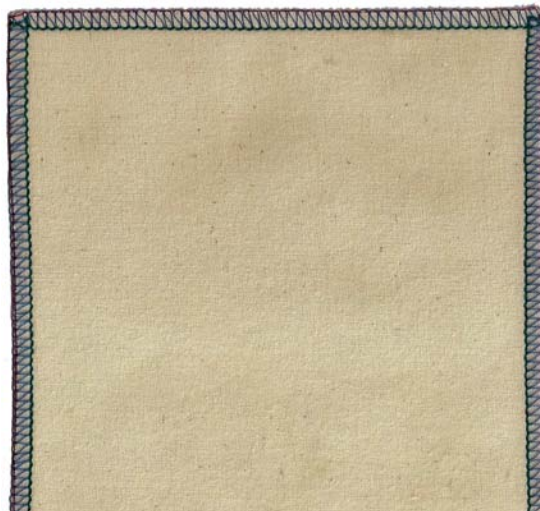
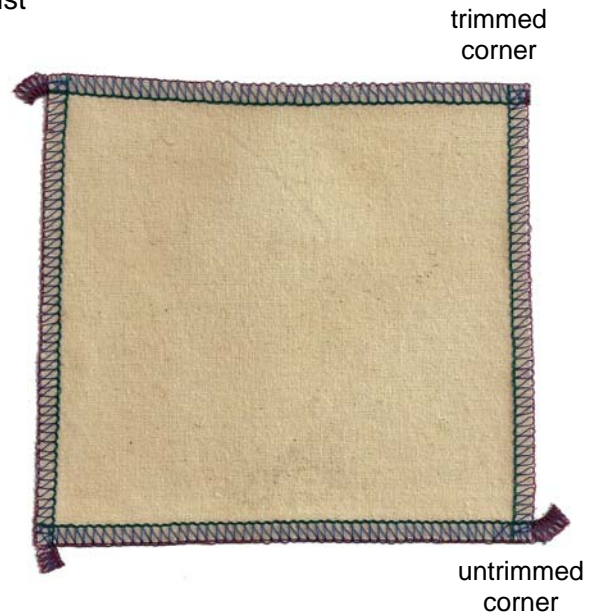

### Suggested Settings

Upper Loper .....	3-5
Lower Loper .....	3-5
Left Needle .....	N/A
Right Needle .....	3-5
Stitch Length .....	2.5
Cutting Width .....	2-3
Differential Feed .....	N

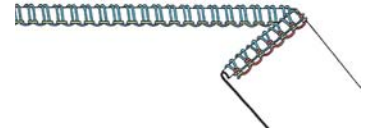

**Fabric:** Medium weight fabric, 4" x 6"  
**Needle:** 80/12 Universal  
**Thread:** 3 cones of serger thread (blue, red, green)  
*Optional: Woolly Nylon thread for upper looper*  
**Presser Foot:** Standard  
**Stitch:** 3-thread Rolled Hem

Using the small screwdriver and brush/needle insertion tool, remove the left needle. Snug the needle set screw after removing the needle.

Thread the serger for a *narrow* 3-thread overlock stitch using the right needle and thread colors to match the color-coded threading path on the serger. Adjust all thread tension settings for a rolled edge as indicated below.

Pull the Stitch Selection lever toward you.

Place the fabric under the presser foot and serge along one 6" edge.

Return stitch length and thread tension levers to normal.

Return the rolled hem lever to normal sewing position.

*Optional: Thread the serger for a 3-thread rolled edge (right needle) with Woolly Nylon in the upper looper. Adjust all thread tension settings as indicated below and serge the edge opposite of the previously stitched rolled edge.*

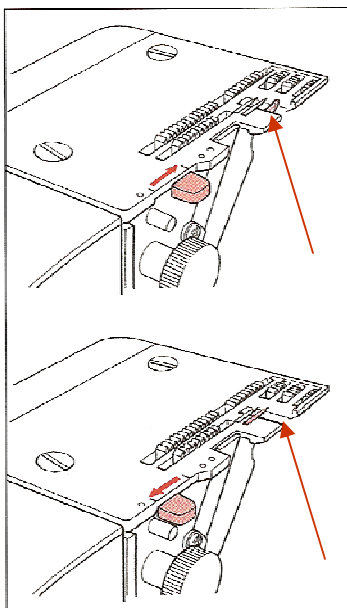
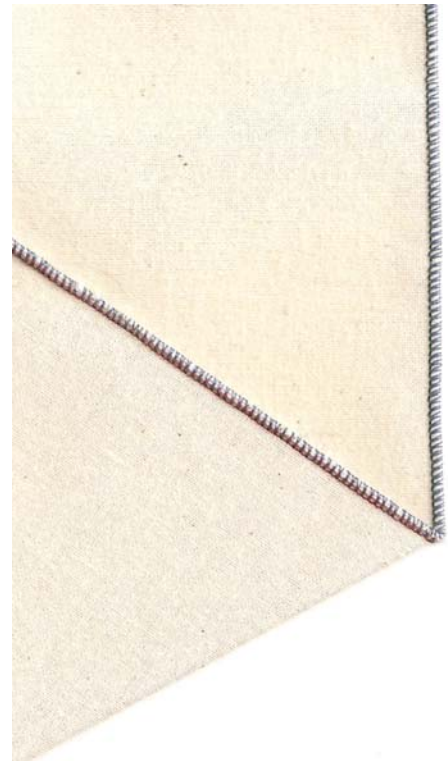

The Stitch Selection lever moves the stitch finger in and out of position.

Push the lever forward for normal serging so the stitch can form over it, keeping the fabric flat (upper ill.).

Pull the lever back so the fabric edge can roll as when stitching a rolled edge (lower ill.).

### Suggested Settings

Upper Looper .....	3-5
Lower Looper .....	7-9
Left Needle.....	N/A
Right Needle .....	3-5
Stitch Length .....	1-1.5
Cutting Width.....	2-3
Differential Feed.....	N

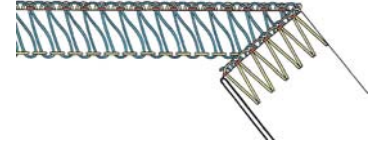

**Fabric:** Firm fabric, 6" x 6"  
**Needle:** 80/12 Universal  
**Thread:** 3 cones of serger thread (blue, red, yellow)  
**Presser Foot:** Standard  
**Stitch:** 3-thread Flatlock

Using the small screwdriver and brush/needle insertion tool, remove the right needle. Snug the needle set screw after removing the needle.

Thread serger for a wide 3-thread flatlock stitch. Adjust all thread tension settings as indicated below. *Note: Sample was stitched with regular thread but a heavy thread such as YLI Jeans Stitch or Designer 6 can be used in the looper for a more decorative look. When working with heavy decorative threads, loosen the upper looper tension and lengthen the stitch length as needed for the desired look.*

Fold the fabric in half, *wrong* sides together, to 3" x 6".  
*Optional: Attach the Right Seam Guide to the serger (700D and 800DL will require the Attachment Base). Move the Right Seam Guide halfway between the needle and the stitch finger.*

Place the fold under the presser foot. Guide the fabric halfway between the left needle and the right edge of the stitch finger (or against the Right Seam Guide).

Slowly serge the fabric. The looper threads will extend beyond the fabric on the right side of fold. *Decorative Thread Tip: To avoid uneven stitches, tangled threads, hiccups, and other imperfections, always serge slowly when working with decorative threads.*

Gently pull the fabric flat.

Return stitch length and thread tension levers to their normal settings.

*Optional: For a narrow flatlock stitch, reset the serger using the right needle*

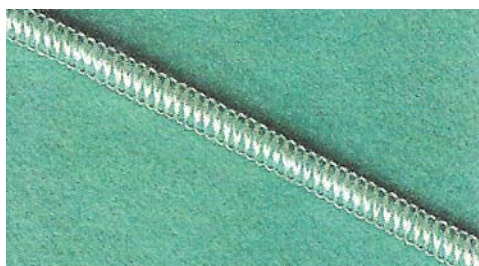

3-thread flatlock with Designer 6 thread in the upper looper

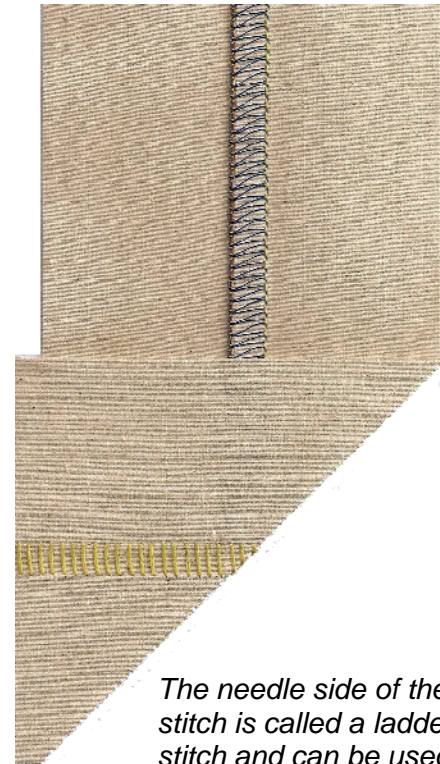

*The needle side of the stitch is called a ladder stitch and can be used as the decorative side if desired.*

### Suggested Settings

Upper Looper.....	3-5
Lower Looper.....	7-9
Left Needle .....	1-2
Right Needle.....	N/A
Stitch Length.....	2.5
Cutting Width .....	3
Differential Feed .....	N

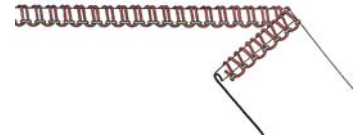

**Fabric:** Medium weight fabric, 4" x 6"  
**Needle:** 80/12 Universal  
**Thread:** 2 cones of serger thread (red, green)  
**Presser Foot:** Standard  
**Stitch:** 2-thread Rolled Hem  
**Accessory:** Upper Looper Converter

Using the small screwdriver and brush/needle insertion tool, remove the left needle. Snug the needle set screw after removing the needle.

Attach the Upper Looper Converter to the upper looper. *Note: This is an optional accessory for the 700D.*

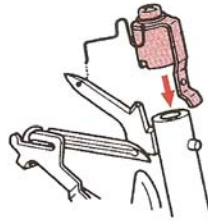

Thread the serger for a 2-thread flatlock stitch using thread colors to match the color-coded threading path on the serger.

Adjust all thread tension settings for a balanced stitch as indicated below.

Pull the Stitch Selection lever toward you.

Place the fabric under the presser foot and serge along one 6" edge, trimming about  $\frac{1}{8}$ " from the raw edge.

Return stitch length and thread tension levers to normal.

Return the Stitch Selection lever to normal serging position.



### Suggested Settings

Upper Looper .....	Converter
Lower Looper.....	3-5
Left Needle .....	N/A
Right Needle.....	3-5
Stitch Length.....	1-1.8
Cutting Width .....	1-1.5
Differential Feed .....	N

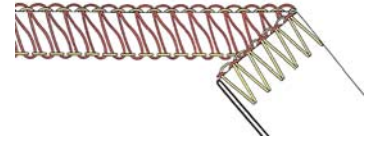

- Fabric:** Firm fabric, 6" x 6"
- Needle:** 80/12 Universal
- Thread:** 2 cones of serger thread (red, yellow)
- Presser Foot:** Standard
- Stitch:** 2-thread Flatlock
- Accessory:** Upper Looper Converter

Using the small screwdriver and brush/needle insertion tool, remove the right needle. Snug the needle set screw after removing the needle.

Attach the Upper Looper Converter to the upper looper. *Note: This is an optional accessory for the 700D.*

Thread serger for a wide 2-thread flatlock stitch. Adjust all thread tension settings as indicated below. *Note: Sample was stitched with regular thread but a heavy thread such as YLI Jeans Stitch or Designer 6 can be used in the looper for a more decorative look. When working with heavy decorative threads, loosen the upper looper tension and lengthen the stitch length as needed for the desired look.*

Fold the fabric in half to 3" x 6" and position it halfway between the left needle and the stitch finger. *Optional: Attach the Right Seam Guide. Move the Right Seam Guide halfway between the needle and the stitch finger.*

Slowly serge the fabric. The looper threads will extend beyond the fabric on the right side of fold. *Decorative Thread Tip: To avoid uneven stitches, tangled threads, hiccups, and other imperfections, always serge slowly when working with decorative threads.*

*Note: Before the fabric is pulled to create the flatlock stitch, the threads form a 2-thread balanced stitch with the threads connecting at the edge of the fabric. This stitch is not strong enough for seaming but can be used as an edge finish for light to medium weight fabrics. Gently pull the fabric flat. Return stitch length and thread tension levers to normal.*

*Optional: For a narrow flatlock stitch, reset the serger using the right needle only.*



*The needle side of the stitch is called a ladder stitch and can be used as the decorative side if desired.*

3-thread flatlock with Designer 6 thread in the upper looper

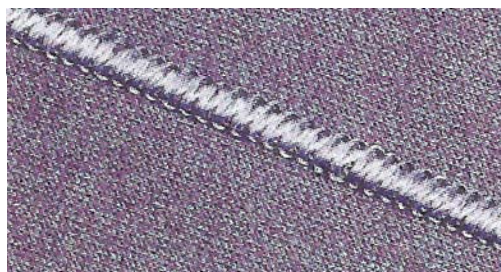

### Suggested Settings

Upper Looper .....	Converter
Lower Looper.....	3-5
Left Needle .....	1-2
Right Needle.....	N/A
Stitch Length.....	2.5
Cutting Width.....	2-3
Differential Feed .....	N

# 4-Thread Balanced Stitch

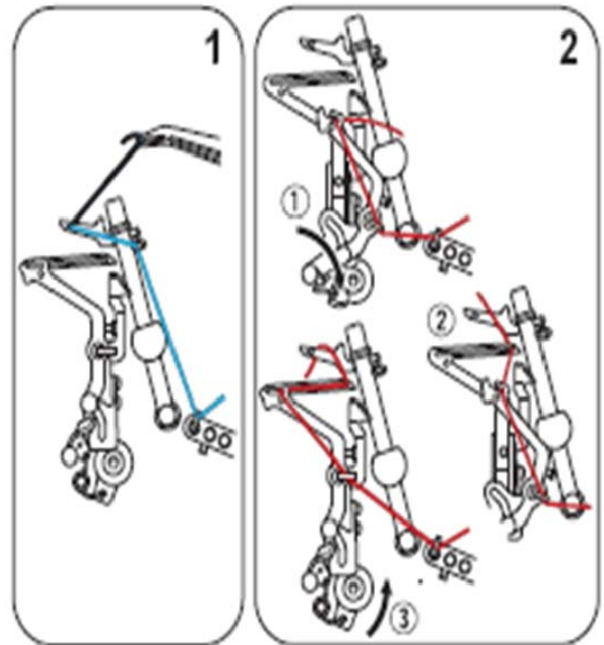
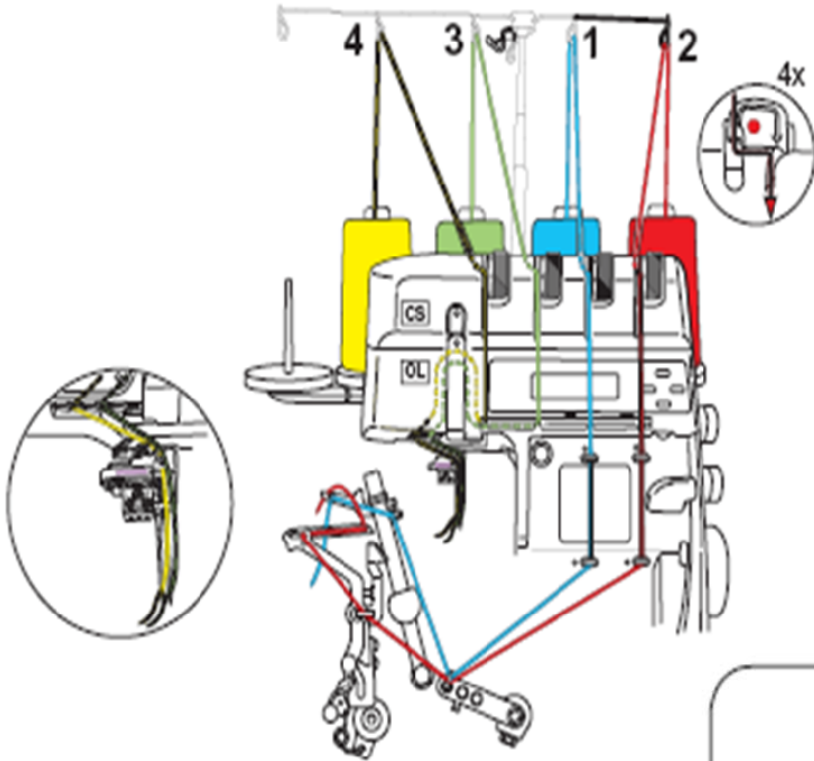
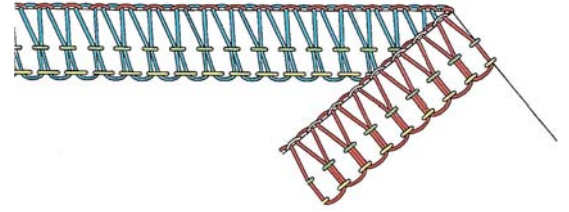

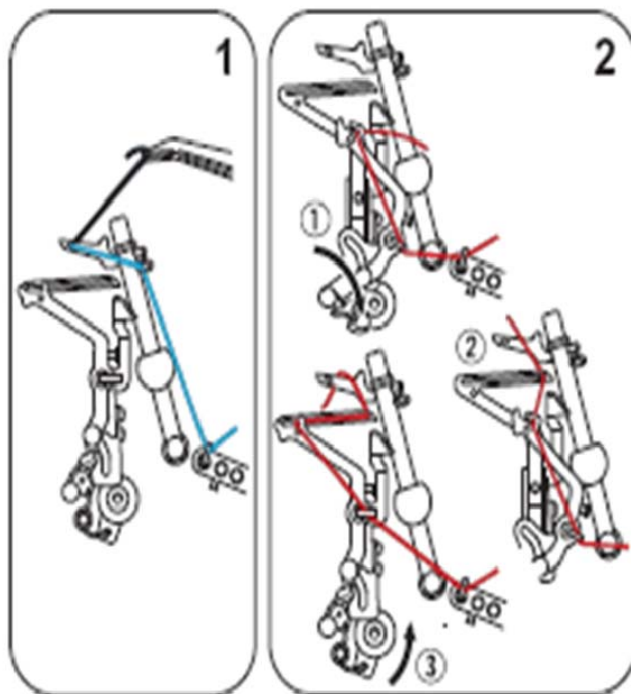
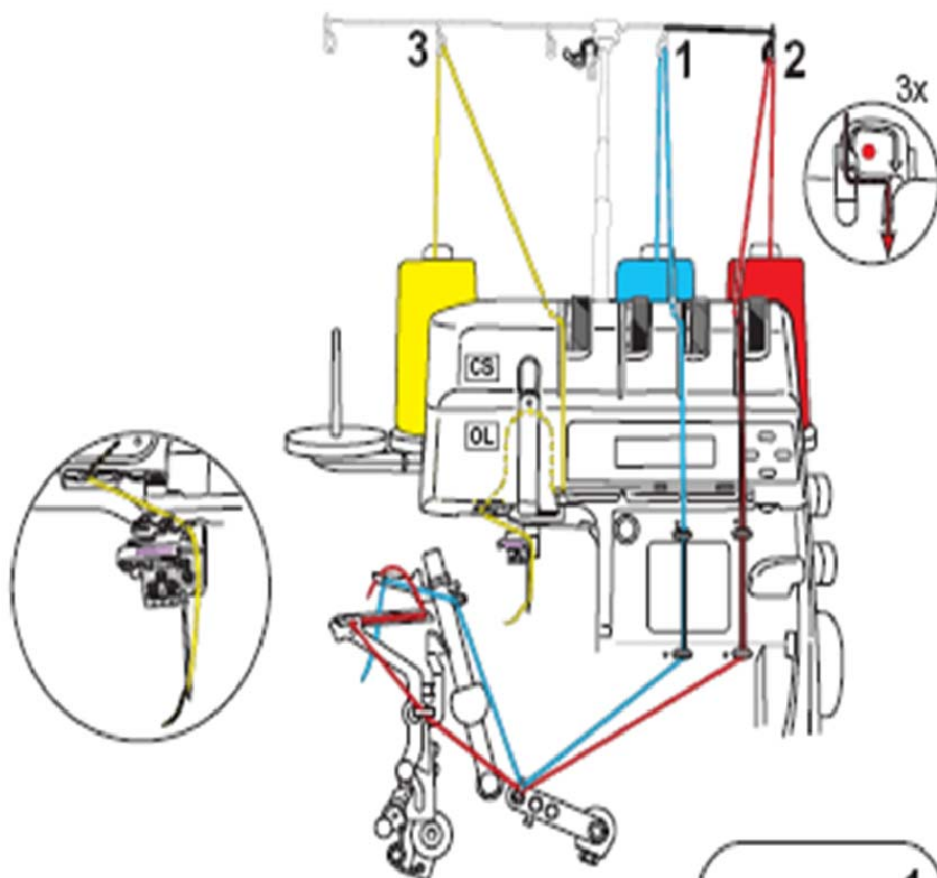
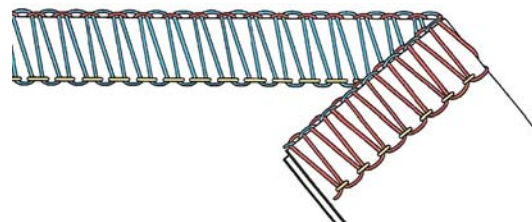

**Narrow 3-thread Overlock Stitch**  
The diagram above shows threading for a *wide* 3-thread balanced overlock stitch. To thread for a *narrow* 3-thread balanced overlock stitch, simply use the right needle instead of the left and follow the green threading path.



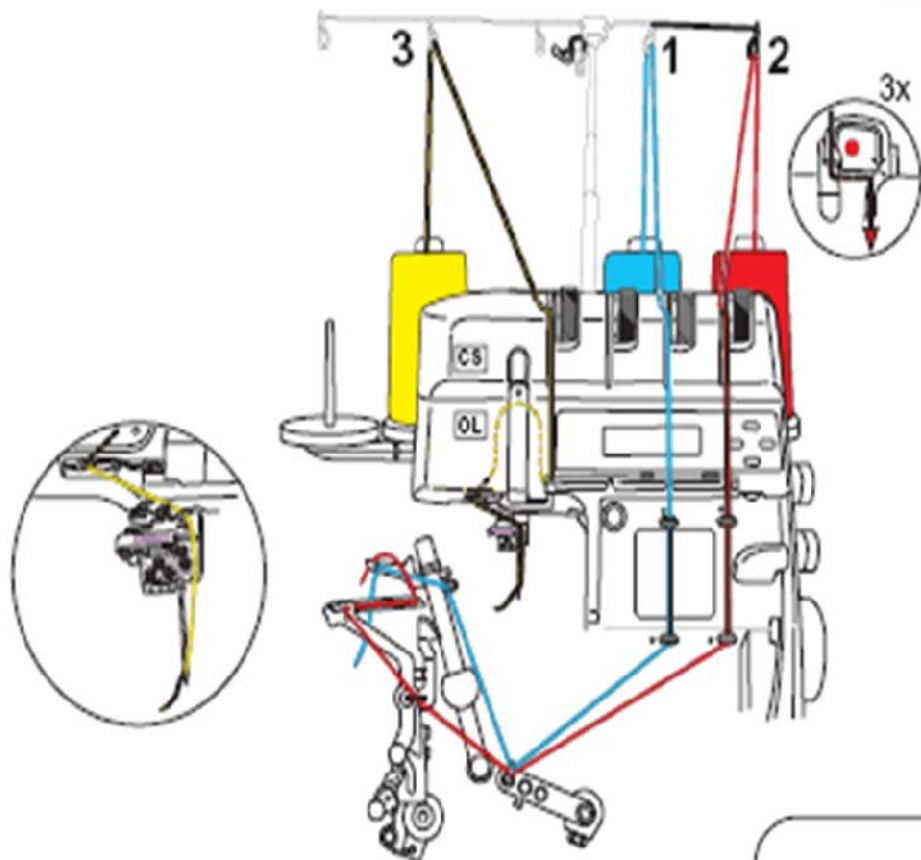
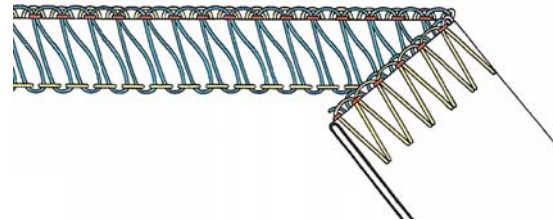

**Narrow 3-thread Flatlock Stitch**  
The diagram above shows threading for a *wide* 3-thread flatlock stitch. To thread for a *narrow* 3-thread flatlock stitch, simply use the right needle instead of the left and follow the green threading path.

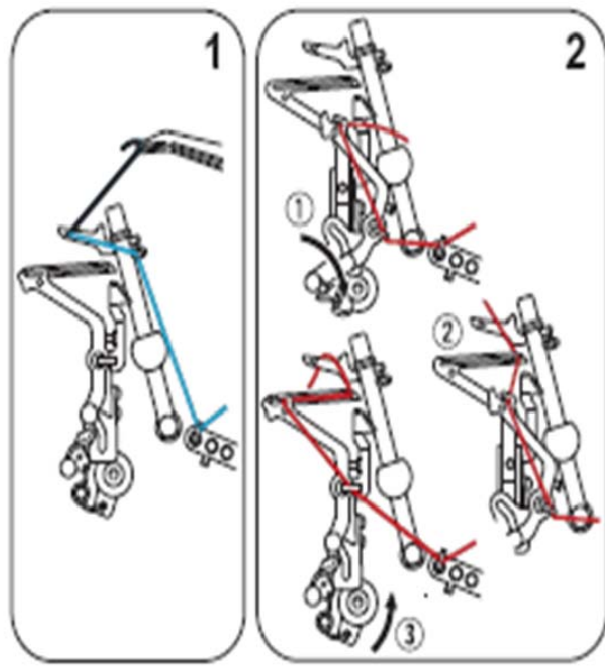

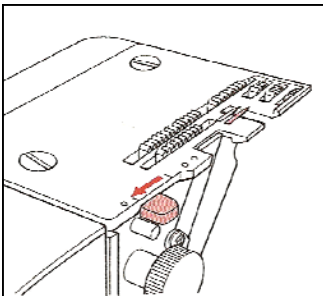
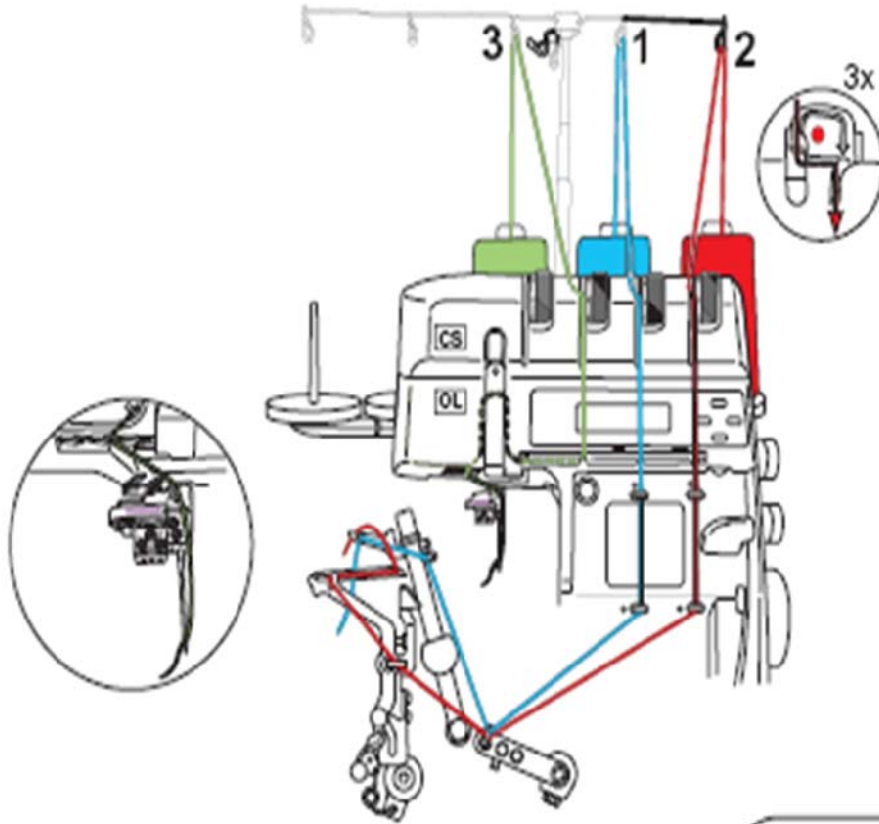
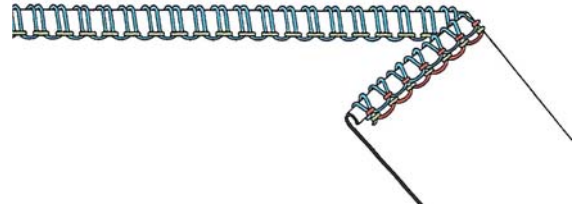

Pull Stitch Selection lever toward you.

